

Cargo 370



ATP

















Isothermal container for the transport of chilled and frozen products at a controlled temperature

- Suitable for supermarket chains, logistics operators, chilled or frozen food distributors and manufacturers, carriers.
- Suitable for loading of commercial vehicles of medium size.
- 370 litres of capacity.
- Total compliance with the cold chain at all stages of transport.
- Speeds up distribution operations at the point of sales: it can be loaded inside the cold room of the wholesale centre and unloaded at the refrigerated counter of the destination supermarket.
- It can be transported using conventional vehicles: it allows to simultaneously transport chilled, frozen and ambient temperature products using a single non-insulated vehicle.
- Manufactured using the rotational moulding technology: mono-block container and door (free of sharp edges, joints and welds).
- Fully recyclable at the end of the operating life.

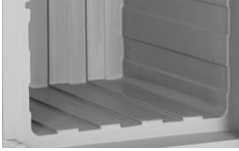
MANUFACTURING MATERIALS

Polyethylene	inner and outer walls of the container and the door; suitable for food contact	Polyurethane	insulating material between the walls of the container and the door; free of CFC and HCFC
Silicone	seal	Nylon	runners
Polypropylene	hinges	Stainless steel	handling handles, closing handle, inner rod of the door
Galvanised steel	hinge rods, connecting rods hinged plates, runner support		

TECHNICAL CHARACTERISTICS

	<p>Available model with collapsible top cage, useful for the transport of products at room temperature.</p>		<p>3 seats for housing of grids positioned at 335/500/665mm from the bottom of the container. Grids available on request.</p>
	<p>4 runners 100 mm diameter (2 fixed and 2 swivel of which one equipped with brake). Support runners plate integrated in the container. Possibility of inclusion of 4 feet h 130 mm in galvanised steel as an alternative to the runners.</p>		<p>Label holder (on request) for the identification of the content or destination. Suitable for A5 format documents.</p>
	<p>Stainless steel locking handle with release button.</p>		<p>Handle prepared for the use of tamper-proof system.</p>
	<p>Chilled and frozen eutectic plates, to increase temperature retention performance over time (on request).</p>		<p>Internal temperature can be checked through a thermometer installed in the door (on request).</p>
	<p>Available (on request) USB data logger to record temperature data during transport.</p>		<p>Internal grooves improving good air circulation.</p>
	<p>Door opens up to 270° with door retaining catch.</p>		<p>Easily removable door seal.</p>
	<p>Dual pivot hinge system. Better stability of the door over time.</p>		<p>Stainless steel rod with 2 hooks integrated inside the door.</p>
	<p>Mono-block structure, no sharp edges, joints and welds.</p>		<p>Insulated with CFC and HCFC-free polyurethane foam.</p>
<p>K</p>	<p>Overall heat transmission coefficient: K = 0.29 W/m²K</p>	<p>°C</p>	<p>Guaranteed for use: from -30° to +100° C.</p>

TECHNICAL SPECIFICATIONS

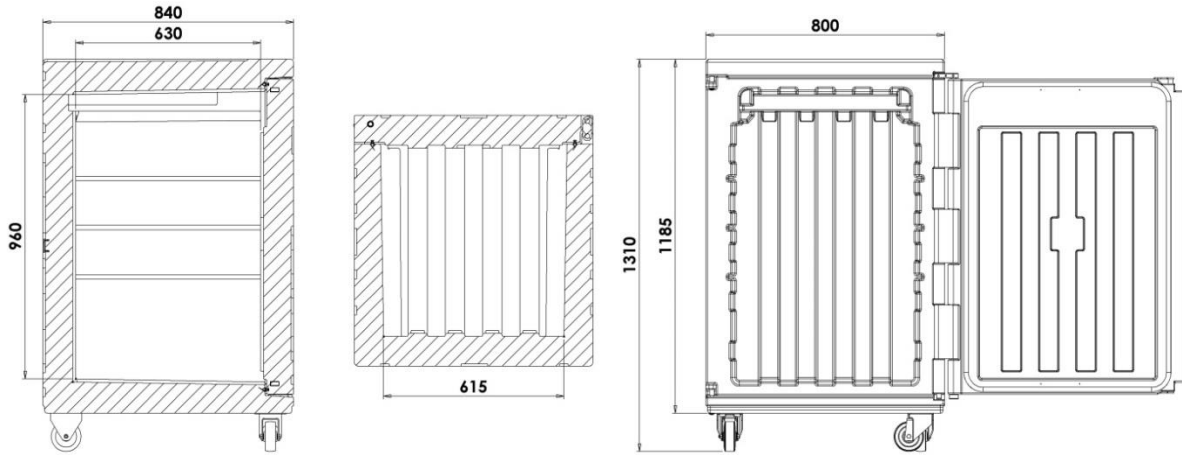

Model	Code	Colour	External dim. (mm)	Internal dim. (mm)	Capacity l	Weight Kg
Cargo 370 with castors	03700001	melange grey blue	800x840xh1310	615x630xh960	370	70
Cargo 370 with feet	03700003	melange grey blue	800x840xh1310	615x630xh960	370	70
Cargo 370 with pallet	03700010	melange grey blue	800x840xh1310	615x630xh960	370	83
Label holder	AMC101	transparent	173xh200	148xh210 -A5-		
Grid in stainless steel	AEA018	stainless	650x610xh16			3.85
Collapsible cage	AEB001	stainless				13
Eutectic plate Chilled +3°C - 2 x Cargo -	PE500001	pink	540x325xh57			6.8
Eutectic plate Frozen - 21°C - 2 x Cargo -	PE500002	blue	540x325xh57			6.8
Data logger USB	AFG002		80x33xh14			
EUTECTIC CONFIGURATION						
FRESH Eutectic	EUT001	melange grey blue	800x840xh1310	550x590xh810	285	113
FROZEN Eutectic	EUT002	melange grey blue	800x840xh1310	550x590xh810	285	113