



**GN 1/1**



## Insulated container with side opening for the transport of products at controlled temperature





- Brand: MELFORM
- Country of origin: ITALY
- Customs code: 39231090
- Compatible with food contact
- Color: melange grey/blue
- Capacity: 48 liters
- Fully recyclable at the end of its operational life.
- Stackable and easy to handle

### MANUFACTURING MATERIALS

<b>Polyethylene</b>	inner and outer walls of the container and door; suitable for food contact	<b>Polyurethane</b>	insulating material between the walls of the container and the door; CFC and HCFC free
<b>Silicone rubber</b>	gasket	<b>Glass fiber reinforced polyamide</b>	hinges, closures
<b>Stainless steel</b>	gripping handles	<b>Acetal resin POM</b>	handle covers

Model	Codicand	EAN code	Ext. dim. (mm)	Int. dim. (mm)	Capacity l	Weight Kg
AL200 melange	AL200007	8022949016777	460x640xh380	330x545xh245	48	10
AL200 blue	AL200001	8022949016715				
AL200 red	AL200004	8022949016746				

## PRODUCT FEATURES

	<p>Equipped with 1 upper seat for housing a plate or a GN 1/1 pan.</p> <p>It can carry:</p> <ul style="list-style-type: none"> <li>• 2 GN 1/1 h100 + 1 Eutectic plate;</li> <li>• 1 GN 1/1 h200 + 1 Eutectic plate.</li> </ul>		<p>Equipped with opening door up to 240° and easily removable, to facilitate washing operations.</p>
	<p>Eutectic plates:</p> <ul style="list-style-type: none"> <li>• warm (red)</li> <li>• fresh (pink)</li> <li>• super fresh (white)</li> <li>• frozen (blue)</li> <li>• frozen plus (Green)</li> </ul> <p>to increase performance thermal maintenance over time (on request).</p>		<p>Sealing gasket of the door easily removable</p>
	<p>Stainless steel grip handles with handle cover.</p>		<p>Closing hook Melform material shockproof.</p>
	<p>Equipped with adjustable vent valve</p>		<p>Provided with zippers made of shockproof material and resistant to stress.</p>
	<p>Maxidolly Cart:</p> <ul style="list-style-type: none"> <li>• capacity 150 Kg;</li> <li>• 4 rubber wheels anti-marking and PP core;</li> <li>• diam wheels: 100 mm;</li> <li>• 2 fixed wheels;</li> <li>• 2 swivel wheels.</li> </ul> <p>Available with chromed or stainless steel handle.</p>		<p>USB datalogger to record temperature during transport.</p>
	<p>Monobloc structure, without edges, joints and welding.</p>	<p>°C</p>	<p>Container granted for use <b>from -30°C to +100°C.</b></p>

## TECHNICAL DATA (mm)

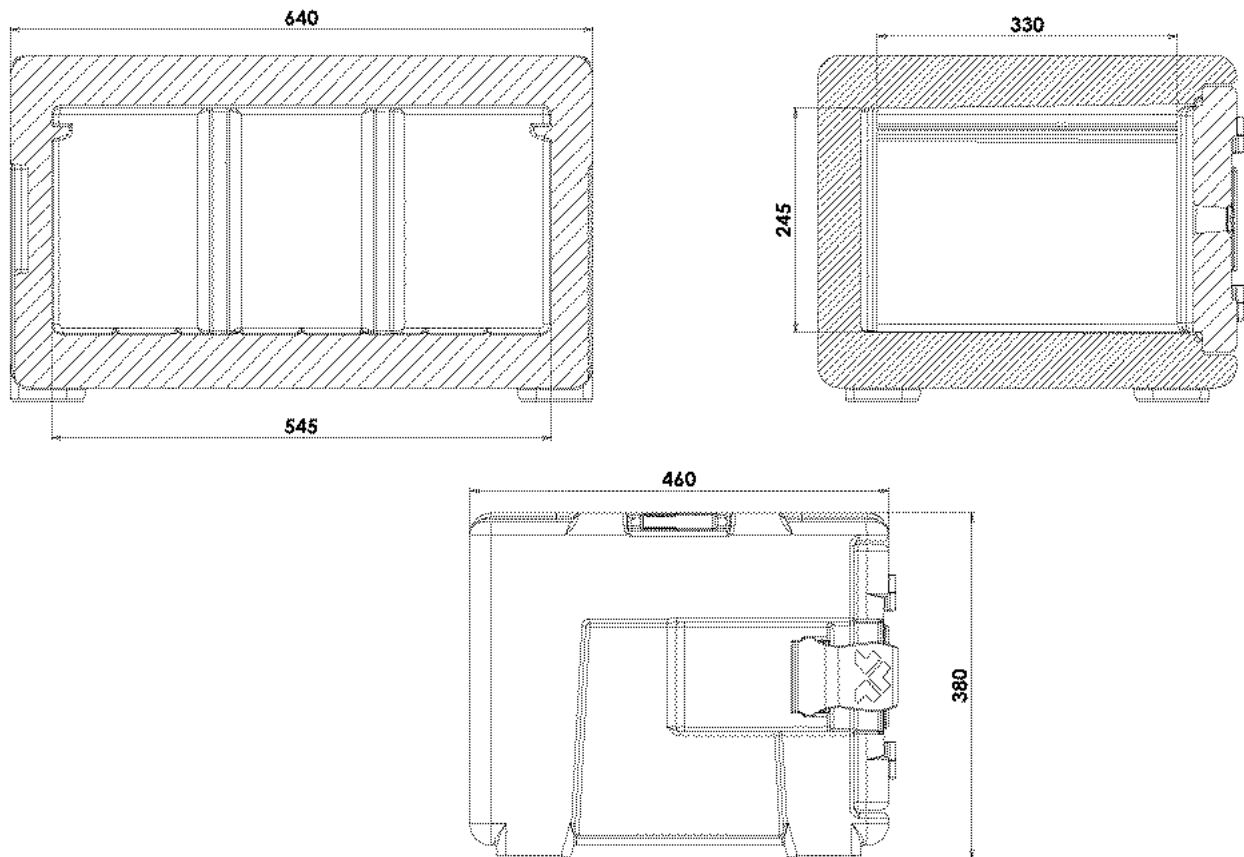

## ACCESSORIES

Model	Codicand	Color	Ext. dim. (mm)	Int. dim. (mm)	Capacity l	Weight Kg
Hot plate <b>GN 1/1</b>	PEGS0003	red	530x325xh30			3
Fresh plate <b>GN 1/1</b>	PEGS0001	rose	530x325xh30			4
Super fresh plate <b>GN 1/1</b>	PEGS9001	white	530x325xh30			4
Frozen plate <b>GN 1/1</b>	PEGS0002	blue	530x325xh30			4
Frozen plus plate <b>GN 1/1</b>	PEGS9008	verde	530x325xh30			4
Maxidolly Cart <b>chrome handle</b>	MAXI0012	Mel. grey blue	525x750xh965			9,4
Maxidolly Cart <b>stainless steel handle</b>	MAXI0011	Mel. grey blue	525x750xh965			9,4
Maxidolly Cart <b>without handle</b>	MAXI9002	Mel. grey blue	525x750xh210			7
Data logger <b>USB</b>	AFG007		80x33xh14			

## SPARE PARTS

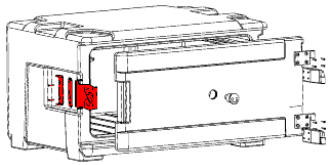

### RRI112

Complete kit chiusura

4 pieces per package

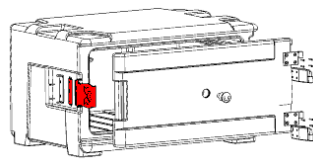

### RRI004

Closure kit (closuret only)

4 pieces per package

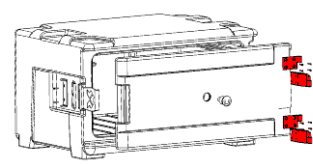

### RRI113

Complete hinge kit

2 pieces per package

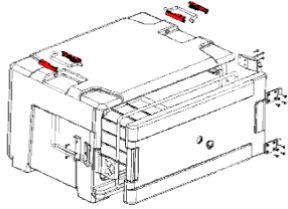

### RRI019

Handle cover kit

2 pieces per package

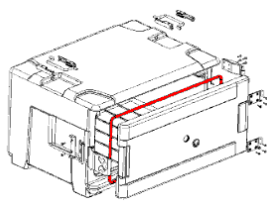

### RRI024

Gasket kit

5 pieces per package

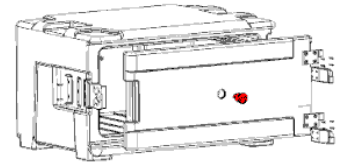

### RRI030

Vent plugs kit

10 pieces per package